

**Report Number: MIC-ASI178049**

**Audit Date :** 23 Oct.,2017

This report is issued by Focus Technology Co., Ltd. (Made-in-China.com) and the supervising inspectorate (Bureau Veritas) to confirm that:

**Company Name :** Sichuan Guangxin Machinery of Grain & Oil Processing Co., Ltd.  
四川广鑫粮油机械制造有限公司

**Showroom :** <http://cnguangxin.en.made-in-china.com>

**Address :** South Section of First Ring Road, Huagai Industrial Park, Anzhou District, Mianyang City, Sichuan Province, China

**Product :** Oil Press, Oil Filter, Rolling Fryer, Oil Extractor, Oil Expeller

**has been on site audited for the Following Scope of Activity**

1. General Information
2. Foreign Trade Capacity
3. Product Research & Development Capacity
4. Production Capacity & Quality Control
5. Working Environment
6. Energy Saving and Emission Reduction
7. Photos



**General Comments:**

Sichuan Guangxin Machinery of Grain & Oil Processing Co., Ltd. is a manufacturer with 262 employees. It was established in 2011, located in South Section of First Ring Road, Huagai Industrial Park, Anzhou District, Mianyang City, Sichuan Province, China. The company's main products include Oil Press, Oil Filter, Rolling Fryer, Oil Extractor, Oil Expeller. It has successful foreign trading experience in Southeast Asia / Mideast, South America, Europe and Africa.



Sign for and on behalf of  
Bureau Veritas

# SUPPLIER ASSESSMENT REPORT

<b>Audited Company</b>	Sichuan Guangxin Machinery of Grain & Oil Processing Co., Ltd. 四川广鑫粮油机械制造有限公司		
<b>Audited Site:</b>	South Section of First Ring Road, Huagai Industrial Park, Anzhou District, Mianyang City, Sichuan Province, China		
<b>Consigner of Assessment</b>	<b>Made-in-China.com</b>		
<b>Audit Type</b>	<input checked="" type="checkbox"/> Initial Audit <input type="checkbox"/> Re-audit		
<b>Audit Date</b>	23 Oct.,2017	<b>Verify Report</b>	<a href="http://www.bvcerchina.cn">www.bvcerchina.cn</a>
<b>Auditor</b>	Eddy Yang	<b>Reviewed by</b>	Jim Li

## CONTENTS

- Part A: General Information**
  - Section 1: Company Overview
  - Section 2: Human Resources
- Part B: Foreign Trade Capacity**
  - Section 1: Export Overall Situation
  - Section 2: Export Business Capacity
  - Section 3: Supplier Management
  - Section 4: After-sales Service Capacity
- Part C: Product Research & Development Capacity**
  - Section 1: Product Research & Development Capacity
- Part D: Management System and Product Certification**
  - Section 1: Management System(s) and Product Certification
- Part E: Production Capacity & Quality Control**
  - Section 1: Production Capacity Section
  - Section 2: Production Process Control
- Part F: Financial Position**
  - Section 1: Financial Data
  - Section 2: Key Performance Indications
  - Section 3: Banking
  - Section 4: Product Insurance
- Part G: Working Environment**
  - Section 1: Working Environment
- Part H: Energy Saving and Emission Reduction**
  - Section 1: Environmental Management
  - Section 2: Water, Gas and Noise Control
- Part I: Industry Information**
  - Section 1: Industry Information
- Part J: Photos**
  - Section 1: Photos of Documents
  - Section 2: Photos of Company

This document is issued by Bureau Veritas. Attention is drawn to the limitation of liability, indemnification and jurisdiction issues defined therein. Any holder of this document is aware that information contained hereon is solely limited to visual examination of the safety and readily accessible portions of consignment and does not exonerate parties to a transaction from exercising all their rights and obligations under the transaction document. Any use, reproduction, distribution, alteration or falsification of the content or appearance of this document is unlawful and offenders may be prosecuted to the fullest extent of the law.

Attention: To check the authenticity of testing/inspection report & certificate, please click: <http://www.bvcerchina.cn/>



## Part A: General Information

### Section 1: Company Overview

1.1 Legal Validity			
Does the company have a valid business license?	<input checked="" type="checkbox"/> Yes <input type="checkbox"/> No <input type="checkbox"/> Others	Registration Number	91510724582165269E
Year of established	13 Sep.,2011	Valid Date	Long Term Valid
Registered address	South Section of First Ring Road, Huagai Industrial Park, Anzhou District, Mianyang City, Sichuan Province, China		
Actual address	South Section of First Ring Road, Huagai Industrial Park, Anzhou District, Mianyang City, Sichuan Province, China		
Does the company in abnormal operation status list of industrial and commercial bureau?	No		
Registered capital	14000000 RMB		
Name of legal representative	Mr. Weixiao Huang		
Business scope	Oil Presser research, design, development, manufacturing and mechanical parts processing, sales. Products after-sale technical services. Agricultural machinery and accessories, hardware and electrical equipment, steel sales. Import and export trade (Except state prohibitions and restrictions) (After approved by the relevant departments to carry out business activities).		
1.2 Basic Information			
Contact person	Ms. Shirley Huang		
Phone number	0086-816-2688216	Fax number	0086-816-2688687
URL/Web address	<a href="http://www.gxoilpress.com">http://www.gxoilpress.com</a>		
Company type	<input type="checkbox"/> Manufacturer <input type="checkbox"/> Trading Company <input checked="" type="checkbox"/> Combined <input type="checkbox"/> Group Corporation		
Type of ownership	<input checked="" type="checkbox"/> Limited Company <input type="checkbox"/> Public Company <input type="checkbox"/> Foreign joint venture <input type="checkbox"/> State-Owned <input type="checkbox"/> Private Owner <input type="checkbox"/> Wholly foreign-owned enterprises		
Associated company	No Associated Company		
Products manufactured / sold scope	Oil Press, Oil Filter, Rolling Fryer, Oil Extractor, Oil Expeller		
1.3 Company Building Information			
According to:			
<input type="checkbox"/> Land certificate <input checked="" type="checkbox"/> Real estate certificate <input type="checkbox"/> Lease agreement <input type="checkbox"/> Observation Estimated on site			
The company area 36295.85 square meters The land occupies 43946.55 square meters. The offices occupy Nil square meters. The workshops occupy Nil square meters.			

## Section 2: Human Resources

### 2.1 Company Chart

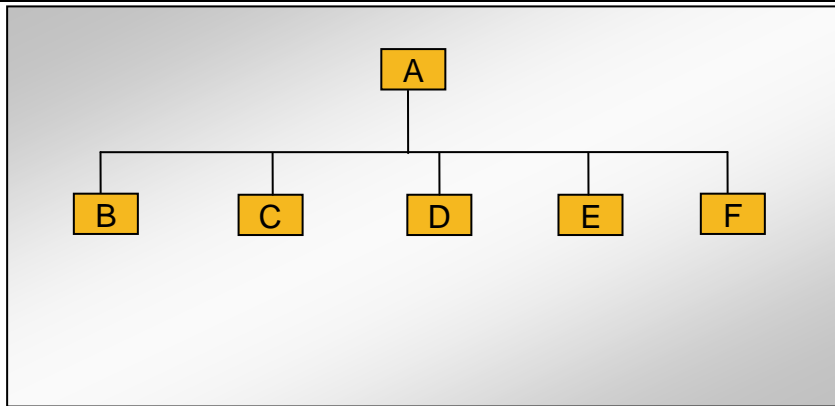

### 2.2 Explanation of Code and Employee Details

Code	Department	Number of employees
A	General Manager	1
B	Sales Department	25
C	Production Department	207
D	Technology Department	7
E	Administration Department	17
F	QC Department	5
<b>Number in total:</b>		262

### 2.3 Key Staff

Title	Full name	Education	Working experience for this trade / total experience
General Manager	Mr. Weixiao Huang	Confidential	38/38 Years
Sales Manager	Mr. Deqiang Zhao	University	23/23 Years
Production Manager	Mr. Mingjian Pu	Confidential	26/26 Years

Remark: Above information of key staff was based on interview with company representative.

## Part B: Foreign Trade Capacity

### Section 1: Export Overall Situation

1.1 Export Overall Situation	
Does the company have a valid Import and Export license?	<input type="checkbox"/> Yes <input checked="" type="checkbox"/> No
The import and export enterprise code.	N/A
The number of foreign trading staff with relevant trading experience.	<input type="checkbox"/> within 1 year staff <input type="checkbox"/> 1-5 years staff <input checked="" type="checkbox"/> 6-10 years 6 staffs <input type="checkbox"/> over 10 years staff Total 6 staffs
The language freely used by foreign trade staff	<input checked="" type="checkbox"/> English <input type="checkbox"/> others:
Annual revenue of previous year	Confidential
Annual export revenue of previous year	Confidential
Estimated export revenue for this year.	Confidential
Overseas agent / branch	<input type="checkbox"/> Yes <input checked="" type="checkbox"/> No
Nearest port	Chongqing Port, Shanghai Port, Guangzhou Port, Qingdao Port
Acceptable quotation terms	<input checked="" type="checkbox"/> FOB <input checked="" type="checkbox"/> CIF <input checked="" type="checkbox"/> CFR
Acceptable payment terms	<input checked="" type="checkbox"/> LC <input checked="" type="checkbox"/> T/T <input checked="" type="checkbox"/> D/P <input checked="" type="checkbox"/> PayPal <input checked="" type="checkbox"/> Western Union <input checked="" type="checkbox"/> Small-amount payment
Average lead time (Peak Season)	<input checked="" type="checkbox"/> within 15 workday <input type="checkbox"/> one month <input type="checkbox"/> 2-3 months <input type="checkbox"/> 4-6 months <input type="checkbox"/> 6-12 months <input type="checkbox"/> more time
Average lead time (Off Season)	<input checked="" type="checkbox"/> within 15 workday <input type="checkbox"/> one month <input type="checkbox"/> 2-3 months <input type="checkbox"/> 4-6 months <input type="checkbox"/> 6-12 months <input type="checkbox"/> more time

### Section 2: Export Business Capacity

2.1 Market Distribution (please list top three areas)		
Market	Main Product	Main client
<input type="checkbox"/> North America		
<input checked="" type="checkbox"/> South America	Oil Press, Oil Filter, Rolling Fryer, Oil Extractor, Oil Expeller	Confidential
<input checked="" type="checkbox"/> Europe	Oil Press, Oil Filter, Rolling Fryer, Oil Extractor, Oil Expeller	Confidential
<input checked="" type="checkbox"/> Southeast Asia/ Mideast	Oil Press, Oil Filter, Rolling Fryer, Oil Extractor, Oil Expeller	Confidential
<input checked="" type="checkbox"/> Africa	Oil Press, Oil Filter, Rolling Fryer, Oil Extractor, Oil Expeller	Confidential
<input type="checkbox"/> East Asia (Japan/ South Korea)		
<input type="checkbox"/> Australia		
<input checked="" type="checkbox"/> Domestic	Oil Press, Oil Filter, Rolling Fryer, Oil Extractor, Oil Expeller	Confidential
<input type="checkbox"/> Others		

### Section 3: Supplier Management

3.1 Supplier Management		
Item	Content	Observations /Comments
1	Does the company establish and implement an effective suppliers' assessment procedure?	<input type="checkbox"/> Have the written procedures and followed records <input type="checkbox"/> Have the written procedures but no records <input type="checkbox"/> Have relevant records without written procedure <input checked="" type="checkbox"/> No written procedures or followed records <input type="checkbox"/> Other
2	Does the company have an updated list of approved suppliers?	<input type="checkbox"/> The approved suppliers list was updated in _____ <input type="checkbox"/> Have the written suppliers without approved signature or date. <input checked="" type="checkbox"/> Provided some suppliers names <input type="checkbox"/> No approved suppliers list <input type="checkbox"/> Other

### Section 4: After-sales Service Capacity

4.1 After-sales Service Capacity		
Item	Content	Observations /Comments
1	Is there a procedure to conduct random product inspection after final packaging in place?	<input type="checkbox"/> Have clear standards and written inspection records <input type="checkbox"/> No written standards but had inspection reports <input type="checkbox"/> Have the procedures but no inspection records <input checked="" type="checkbox"/> It's not necessary to carry out the inspection <input type="checkbox"/> Other
2	Is there a clear procedure for handling customer complaints?	<input checked="" type="checkbox"/> Has the clear procedure and followed records <input type="checkbox"/> Has the procedure but no written records. <input type="checkbox"/> No written procedures or records. <input type="checkbox"/> Other
3	Can the finished/packaged product be traced by lot identification to the appropriate raw materials test reports?	<input type="checkbox"/> Have the procedures to trace the raw materials. <input checked="" type="checkbox"/> Can trace main materials <input type="checkbox"/> Can trace production date. <input type="checkbox"/> Can't trace products <input type="checkbox"/> Other
4	Are corrective & preventive actions mechanism established and implemented effectively (including the suppliers/ sub-contractors control, incoming inspection, process control, final inspection and customer complaint)?	<input checked="" type="checkbox"/> Has the clear procedure and followed records <input type="checkbox"/> Has the procedure but no written records. <input type="checkbox"/> No written procedures or records. <input type="checkbox"/> Other









## Part C: Product Research & Development Capacity

1.1 Product Research & Development Capacity	
The amount of R&D and relevant working experience.	<input type="checkbox"/> within 1year staff <input type="checkbox"/> 1-5 years staff <input checked="" type="checkbox"/> 6-10 years 7 staffs <input type="checkbox"/> over 10 years staff Total 7 engineers
What is the main job responsibility for R&D engineers?	New products design and production technical support.
Is there any relevant design input, output, review, verification and validation documentation available for auditor to review?	YES. The company has established R&D control procedure and relevant records were kept in document.
Is there any special software or instrument used by the R&D staffs during the design process of new products? If yes, please list the main software or instrument.	YES. Software: AutoCAD, Creo, CAXA. No Special Instrument.
Does the company have an effective design change control procedure in place?	YES. The company has established effective design change control procedure.
Please list the patent certificates and qualification license.	N/A



## Part E: Production Capacity & Quality Control

### Section 1: Production Capacity

1.1 Production Workflow Chart					
	→		→		→
Parts Machining		Heat Treatment		Assembling & Commissioning	
					
Packaging					
1.2 Products Situation (Top three Product Categories)					
Product	Price range	Min. order quantity	Top monthly output	Average monthly output	Total in 2016
 Oil Press	Confidential	1 Set	600 Sets	500 Sets	6000 Sets
1.3 Main Facilities					
Picture	Facility name	Brand or Country/Region of origin	Target Value/machine*day	Quantity	
	Bending Facility	China	Confidential	3	
	CNC	China	Confidential	10	





BUREAU VERITAS

Bureau Veritas No: MIC-ASI178049

Made-in-China.com™

Connecting Buyers with Chinese Suppliers

	Forging Facility	China	Confidential	2
	Gear-hobbing Facility	China	Confidential	8
	Drilling Facility	China	Confidential	4
	Grinding Facility	China	Confidential	9
	Lathing Facility	China	Confidential	16
	Planing Facility	China	Confidential	16

This document is issued by Bureau Veritas. Attention is drawn to the limitation of liability, indemnification and jurisdiction issues defined therein. Any holder of this document is aware that information contained hereon is solely limited to visual examination of the safety and readily accessible portions of consignment and findings at the time of its intervention only and within the limits of Client's instructions, if any. The company's sole responsibility is to its authorized clients. It does not exonerate parties to a transaction from exercising all their rights and obligations under the transaction document. Any use, reproduction, alteration, distribution, or falsification of the content or appearance of this document is unlawful and offenders may be prosecuted to the fullest extent of the law.

Attention: To check the authenticity of testing/inspection report & certificate, please click: <http://www.bvcerchina.cn/>



## Section 2: Production Process Control

2.1 Production Process Control		
Item	Content	Observations /Comments
1	Product R&D capacity	<input checked="" type="checkbox"/> Own brand <input type="checkbox"/> ODM <input type="checkbox"/> OEM
2	Are the environmental conditions, such as tidiness and cleanliness being controlled and suitable for the operation performed?	<input type="checkbox"/> Very tidy <input checked="" type="checkbox"/> Normal <input type="checkbox"/> Need to improve <input type="checkbox"/> Very poor
3	Are the necessary items /documents provided at appropriate location and under control?	<input checked="" type="checkbox"/> Work Instructions /procedures <input type="checkbox"/> Workmanship standard /acceptance <input type="checkbox"/> Golden sample /Approval sample <input type="checkbox"/> Product picture <input type="checkbox"/> Verbal by workshop director
4	Are written instructions available for incoming material inspections /testing? Is the relevant record maintained?	<input checked="" type="checkbox"/> Has instructions and uniformly followed <input type="checkbox"/> Has instruction but no written records <input type="checkbox"/> Materials checked by storage staff
5	Are written inspections /testing instructions available for finished products? Is the relevant record maintained?	<input checked="" type="checkbox"/> Have instructions and uniformly followed <input type="checkbox"/> Have instruction but no written records <input type="checkbox"/> Finished product checked by packing staff
6	What type of inspection is used for finished products?	<input type="checkbox"/> Random inspection <input type="checkbox"/> Visual inspection <input type="checkbox"/> Function inspection <input checked="" type="checkbox"/> 100% inspection <input checked="" type="checkbox"/> Visual inspection <input checked="" type="checkbox"/> Function inspection
7	Are non-conforming units clearly marked/ segregated to prevent accidental dispatch?	<input checked="" type="checkbox"/> Marked and segregated <input type="checkbox"/> Segregated but not marked clearly <input type="checkbox"/> Not found on site
8	How are the non-conforming units handled?	<input checked="" type="checkbox"/> Repaired and re-inspection <input type="checkbox"/> Picked out <input type="checkbox"/> Used under control <input type="checkbox"/> Others

## Part G: Working Environment

### Section 1: Working Environment

1.1 Welfare Benefits		
Item	Content	Observations /Comments
1	Does the company have effective procedures to verify the age of staff at the time of recruitment?	<input checked="" type="checkbox"/> Has written procedure and keeps adequate age documents of workers <input type="checkbox"/> Has written procedure but doesn't follow records <input type="checkbox"/> Hasn't written procedure or follows records
2	Do all workers sign employment contracts with the factory?	<input checked="" type="checkbox"/> All workers sign employment contracts <input type="checkbox"/> Some workers sign employment contracts <input type="checkbox"/> Only management staff sign employment contracts <input type="checkbox"/> No staff sign employment contracts
3	Is statutory contribution required for all employees' social insurance (e.g. health insurance, unemployment insurance, accident insurance etc.) paid for by the enterprise?	<input checked="" type="checkbox"/> All workers have social insurance. <input type="checkbox"/> Some workers have social insurance <input type="checkbox"/> Only management staffs have social insurance <input type="checkbox"/> No staff have social insurance
4	Does the company have a clear and effective policy on working hours, rest and vacations? If does, please list it.	<input checked="" type="checkbox"/> All staffs work kept to the policy <input type="checkbox"/> Most of the time it keeps to the policy except midseason. <input type="checkbox"/> Usually needs overtime. <input type="checkbox"/> No relevant records for working hours Describe the working hours: 8 Hours in normal working day
5	Does the company pay extra remunerations for all overtime work?	<input type="checkbox"/> For all overtime work. <input checked="" type="checkbox"/> For official holidays <input type="checkbox"/> For official holidays except weekend. <input type="checkbox"/> No extra remunerations for overtime.
6	Does the company have dormitories for staff? If yes, please describe the condition.	<input type="checkbox"/> Provide dormitories for all staff <input checked="" type="checkbox"/> Provide dormitories for workers <input type="checkbox"/> Provide dormitories for management staff <input type="checkbox"/> No dormitories were provided. Describe the condition: The dormitories are clean and tidy.
1.2 Labor Protection		
Item	Content	Observations /Comments
1	Are there uniforms for all staff in company?	<input type="checkbox"/> Yes <input checked="" type="checkbox"/> No <input type="checkbox"/> Other
2	Is the emergency medical supplies enough and easily used in workshop?	<input checked="" type="checkbox"/> Yes <input type="checkbox"/> No <input type="checkbox"/> Other
3	Does the company arrange health and safety training for new workers?	<input checked="" type="checkbox"/> Yes <input type="checkbox"/> No <input type="checkbox"/> Other
4	Do the workers have the appropriate protective equipment during operation in workshop? Such as gloves, masks.	<input checked="" type="checkbox"/> Yes <input type="checkbox"/> No <input type="checkbox"/> Other
5	Is there training needed and carried out for fire protection?	<input checked="" type="checkbox"/> Yes <input type="checkbox"/> No <input type="checkbox"/> Other

## Part H: Energy Saving and Emission Reduction

### Section 1: Environmental Management

1.1 Environmental Management		
Item	Content	Observations /Comments
1	Environmental Management System	<input type="checkbox"/> ISO 14001 Certificate <input type="checkbox"/> Cleaner production management <input checked="" type="checkbox"/> NIL
2	Environmental Impact Assessment	<input type="checkbox"/> The Report of Environmental impact assessment is approved by EPA . <input checked="" type="checkbox"/> NIL
3	Check and Acceptance of Completed Constructive Projects	<input checked="" type="checkbox"/> The Report Completed Constructive Projects Inspection and Acceptance is approved. <input type="checkbox"/> NIL
4	"Three Simultaneity" for Environmental protection	<input type="checkbox"/> The Report of "Three Simultaneity" for Environmental protection Inspection and Acceptance is available. <input checked="" type="checkbox"/> NIL

### Section 2: Water, Gas and Noise Control

2.1 Water, Gas and Noise Control		
Item	Content	Observations /Comments
1	Water-intaking	<input type="checkbox"/> Water-intaking license <input type="checkbox"/> No water-intaking license <input checked="" type="checkbox"/> No water taken from natural water body
2	Waste water	<input type="checkbox"/> Water-draining license or contract <input type="checkbox"/> Having carried out waste water treatment before draining <input type="checkbox"/> Having carried out waste water monitoring and the result of which being within the standard limit <input checked="" type="checkbox"/> No detail activities were found
3	Emission to air	<input type="checkbox"/> Air pollutant emission license <input type="checkbox"/> Having carried out air pollutant emission monitoring and the result of which being within the standard limit <input checked="" type="checkbox"/> No detail activities were found to reduce emission to air
4	Classification and Recycling for solid waste	<input type="checkbox"/> Having applied trash classification recycling <input checked="" type="checkbox"/> Having special warehouse for hazardous waste <input type="checkbox"/> No detail activities were found
5	Noise	<input type="checkbox"/> The company carried out noise monitoring and the result of which being within the standard limit one time per year <input checked="" type="checkbox"/> No detail activities were found

This document is issued by Bureau Veritas. Attention is drawn to the limitation of liability, indemnification and jurisdiction issues defined therein. Any holder of this document shall be aware that information contained hereon is solely limited to visual examination of the safety and readily accessible portions of consignment and does not constitute a guarantee of safety. The findings at the time of its intervention only and within the limits of Client's instructions, if any. The company's sole responsibility is to its clients and it does not exonerate parties to a transaction from exercising all their rights and obligations under the transaction document. Any unauthorized use, reproduction, modification, or falsification of the content or appearance of this document is unlawful and offenders may be prosecuted to the fullest extent of the law.

Attention: To check the authenticity of testing/inspection report & certificate, please click: <http://www.bvcerchina.cn/>



Part J: Photos

Section 1: Photos of Documents

1.1 Photos of Documents

Description: Business License Combined with Organization Code Certificate, Tax Registration Certificate (Original)



Description: Business License Combined with Organization Code Certificate, Tax Registration Certificate (Duplicate)



Description: Permit for Opening Bank Account



This document is provided by Bureau Veritas. Attention is drawn to the limitation of liability, indemnification and jurisdiction issues defined therein. Any holder of this document is aware that information contained hereon is solely limited to visual examination of the safety and readily accessible portions of consignment and does not represent findings at the time of its intervention only and within the limits of Client's instructions, if any. The company's sole responsibility is to its authorized consignee. The use of this document does not exonerate parties to a transaction from exercising all their rights and obligations under the transaction document. Any use of this document for any purpose other than the one stated above is unauthorized, and any falsification of the content or appearance of this document is unlawful and offenders may be prosecuted to the fullest extent of the law.

Attention: To check the authenticity of testing/inspection report & certificate, please click: <http://www.bvcerchina.cn/>





BUREAU VERITAS

Bureau Veritas No: MIC-ASI178049

Made-in-China.com<sup>TM</sup>

Connecting Buyers with Chinese Suppliers

## Section 2: Photos of Company

### 2.1 Photos of Company and Product Sample

Description: Company Gate



Description: Office



Description: Workshop



Description: Workshop



Description: Workshop



Description: Warehouse



Description: Forging Facility

Description: CNC

This document is issued by Bureau Veritas. Attention is drawn to the limitation of liability, indemnification and jurisdiction issues defined therein. Any holder of this document is aware that information contained hereon is solely limited to visual examination of the safety and readily accessible portions of consignment and does not exonerate parties to a transaction from exercising all their rights and obligations under the transaction document. Any use, reproduction, modification, distribution, falsification of the content or appearance of this document is unlawful and offenders may be prosecuted to the fullest extent of the law.



Attention: To check the authenticity of testing/inspection report & certificate, please click: <http://www.bvcerchina.cn/>



BUREAU VERITAS

Bureau Veritas No: MIC-ASI178049

Made-in-China.com™

Connecting Buyers with Chinese Suppliers



Made-in-China.com

Description: Product Sample



Made-in-China.com

Description: Product Sample



Made-in-China.com

Description: Product Sample



Made-in-China.com

Description: Product Sample



Made-in-China.com

Description: Product Sample



Made-in-China.com

Description: Product Sample

This document is issued by Bureau Veritas. Attention is drawn to the limitation of liability, indemnification and jurisdiction issues defined therein. Any holder of this document is advised that information contained hereon is solely limited to visual examination of the safety and readily accessible portions of consignment and any findings at the time of its intervention only and within the limits of Client's instructions, if any. The company's sole responsibility is to its client and it does not exonerate parties to a transaction from exercising all their rights and obligations under the transaction document. Any unauthorized use, alteration, falsification or falsification of the content or appearance of this document is unlawful and offenders may be prosecuted to the fullest extent of the law.

Attention: To check the authenticity of testing/inspection report & certificate, please click: <http://www.bvcerchina.cn/>





**BUREAU  
VERITAS**

**Bureau Veritas No: MIC-ASI178049**

**Made-in-China.com**<sup>TM</sup>

Connecting Buyers with Chinese Suppliers



-- End of the Report --

This document is issued by Bureau Veritas. Attention is drawn to the limitation of liability, indemnification and jurisdiction issues defined therein. Any holder of this document is aware that information contained hereon is solely limited to visual examination of the safety and readily accessible portions of consignment and findings at the time of its intervention only and within the limits of Client's instructions, if any. The company's sole responsibility is to its client. This document does not exonerate parties to a transaction from exercising all their rights and obligations under the transaction document. Any unauthorized use, reproduction, modification, distribution, or falsification of the content or appearance of this document is unlawful and offenders may be prosecuted to the fullest extent of the law.

Attention: To check the authenticity of testing/inspection report & certificate, please click: <http://www.bvcerchina.cn/>

Page No.: 16 of 16

